

Data sheets

Semi-hermetic compact compressors > CXH series - Vi 3.1 high compression ratio / for HFC - HCFC - HFO

Technical data:		
Rotors	#	2
Displacement @ 50 Hz	m ³ /h [50Hz]	340
Displacement @ 60 Hz	m ³ /h [60Hz]	408
Compressor version[1]		1
Motor power (HP)		90
Motor power (kW)		67
Motor voltage at 50 Hz[2]	V/ph/Hz	400 (+/-10%) V/3/50Hz PWS
Motor voltage at 60 Hz[2]	V/ph/Hz	460 (+/-10%) V/3/60Hz PWS
PWS partition		50-50
Capacity control (CC) step	%	100-75-50-25
Capacity control (CC) stepless	%	100-50
MRA, maximum operating current at 400V/50Hz and 460V/60Hz	A	160
LRA, maximum starting current at 400V/50Hz and 460V/60Hz, PWS motor	A	405
LRA, maximum starting current at 400V/50Hz and 460V/60Hz, PWS motor with DOL connection	A	649
Max power consumption	kW [@ 50Hz]	103.2
Frequency min	Hz	30
Frequency max[3]	Hz	70
Protection device		INT69 FRYL Diagnose
Enclosure class		IP65
Maximum pressure HP	bar	30
Maximum pressure LP	bar	20.5
Oil type[4]		POE 170 cSt
Oil charge	l	11
Oil filter		Standard; replaceable
Crankcase heater		Standard; integrate
Oil level sight glass		1
Oil water cooling		Standard
Integrated check valve		Standard
Maximum oil temperature sensor		Standard
Suction plug (SL) mm	mm	79.4
Suction plug (SL) inch	inch	3" 1/8
Discharge valve (DV) mm	mm	54
Discharge valve DV inch	inch	2" 1/8
Net weight	kg	550
Length	mm	1393
Max Width	mm	560
Maximum height	mm	624
Sound power level (5/50, R134a)[5][5]	dB(A)	78.1
Compressor body material		Cast Iron

- [1] Motor version: 1, high and middle temperature, all refrigerants; 2, low and middle temperature, all refrigerants; 3 ECOinside, low temperature, only R134a and R1234ze
- [2] Other available on request
- [3] Maximum frequency depends from the working condition: see FSS3 (Frascold selection software)
- [4] Different kind of oil available on request
- [5] Sound pressure in free-field, semi-spherical emission, at 1 meter of distance, at 50Hz; power and pressure levels in different condition are available on FSS2

Data sheets

Semi-hermetic compact compressors > CXH series - Vi 3.1 high compression ratio / for HFC - HCFC - HFO

Accessories:	
DOL bridge bars	T00WK1200
Suction valve	T00SK103900B
Optoelectronic oil level switch	T00WP253
Filter clogging switch	T00W3501122
Motor cooling by means of suction gas	T00WK1400
Valve+muffler for ECO/liquid injection	T00WK1500
Rubber vibration absorber kit	T00SK205200
Oil separator	See if You need and the selection on FSS
Nipples for oil cooler connection	T00WK1450

Data sheets

Semi-hermetic compact compressors > CXH series - Vi 3.1 high compression ratio / for HFC - HCFC - HFO

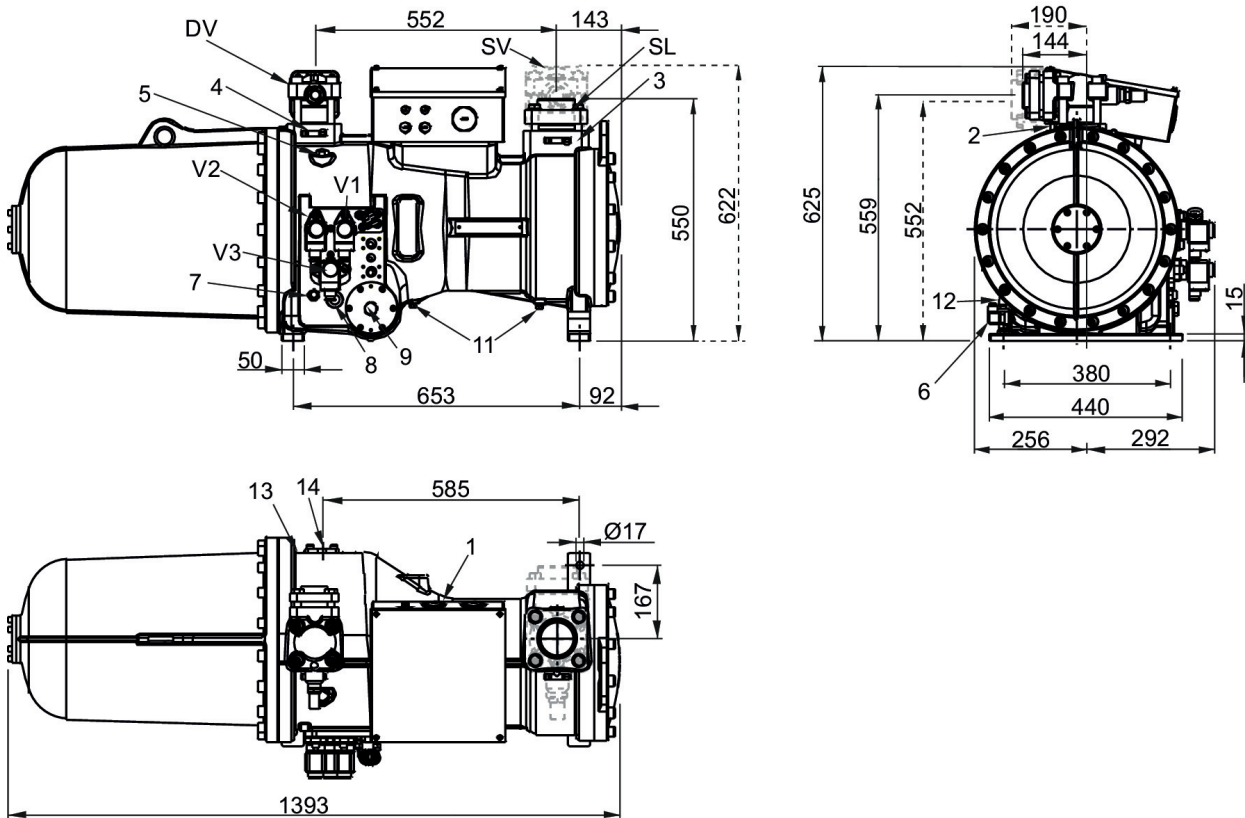

Dimensional drawing:

1	Low pressure connection	1/8" NPT
2	High pressure connection	1/8" NPT
3	Low pressure connection	1/4"SAE x 1/4"SAE
4	High pressure connection	1/4"SAE x 1/4"SAE
5	Oil charge plug	3/8"GAS
6	Crankcase heater	-
7	Oil level switch connection	3/4"NPT
8	Oil level sight glass	-
9	Connection for filter clogging sensor	1/2"GAS
10	Connection for oil cooler	1/2"NPT
11	Connection for oil drain	1/4"NPT
12	Oil drain valve	1/8" NPT
13	Maximum oil temperature sensor	-
14	Connection for ECO/liquid injection	Ø1"1/8
V1	Capacity control valve (step 1)	-

V2	Capacity control valve (step 2)	-
V3	Capacity control valve (step 3)	-
SV	Suction valve	79.4mm - 3"1/8
SL	Suction plug	79.4mm - 3"1/8
DV	Discharge valve	54mm - 2"1/8
NP	Name plate	-